

ROOM AIR CONDITIONER INSTALLATION MANUAL

- Please read this installation manual completely before installing the product.
- When the power cord is damaged, replacement work shall be performed by authorized personnel only.
- Installation work must be performed in accordance with the national wiring standards by authorized personnel only.
- Contact the authorised service technician for repair or maintenance of this unit.

CONTENTS

SAFETY PRECAUTIONS.....	2
INSTALLATION OF INDOOR AND OUTDOOR UNITS.....	3
ELECTRICAL WORK	9
AIR PURGING	11
TEST RUNNING.....	13

 **WARNING**

Do not install, remove and reinstall the unit by yourself.

- Improper installation will cause water leakage, electrical shock, or fire. Please consult authorized dealer or specialist for the installation work. Please note fault caused by improper installation is not covered by warranty.
- Unit must be installed in an easily accessible area. Any additional cost required to hire a special equipment to service the unit will be the responsibility of the customer.

SAFETY PRECAUTIONS

The following should be always observed for safety:

- Be sure to read the following WARNING before installing the air conditioner.
- Be sure to observe the cautions specified here as they include important items related to safety.
- After reading this instructions, be sure to keep it together with the owners manual in a handy place for future reference.

WARNING

Do not install it yourself.

- Incorrect installation could cause injury due to fire, electric shock, the unit falling or leakage of water. Consult the dealer from whom you purchased the unit or special installer

Install the unit securely in a place which can bear the weight of the unit.

- When installed in an insufficiently strong place, the unit could fall causing injury.

Use the specified wires to connect the indoor and outdoor units securely and attach the wires firmly to the terminal board connecting sections so the stress of the wires is not applied to the sections

- Incorrect connection and fixing could cause a fire.

Be sure to use the part provided or specified parts for the installation work.

- The use of defective parts could cause an injury due to a fire, electric shock, the unit falling, etc.

Perform the installation securely referring to the installation instruction.

- Incorrect installation could cause a personnel injury due to fire, electric shock, the unit falling or leakage of water.

Perform electrical work according to the installation manual and be sure to use an exclusive circuit.

- If the capacity of the power circuit is insufficient or there is incomplete electrical work, it could result in a fire or an electric shock.

Check that the refrigerant gas does not leak after installation is completed.

Attach the electrical part cover to the outdoor unit and the service panel to the indoor unit securely.

- If the electrical part covers of the outdoor unit and/or the service panel of the indoor unit are not attached securely, it could result in a fire or electrical shock due to dust, water, etc.

CAUTIONS

Do not install the unit in a place where a flammable gas leaks.

- If gas leaks and accumulates in the area surrounding the unit, it could cause a explosion.

Perform the drainage/piping work according to the installation instruction.

- If there is a defect in the drainage/piping work, water could leak from the unit and household goods could get wet and be damaged.

Read completely, then follow step by step.

Indoor unit

- Do not expose the indoor unit to heat or steam.
- Select a place where there are no obstacles in front or around the unit.
- Make sure that condensation drainage can be conveniently routed away.
- Do not install near a doorway.
- Ensure that the space on the left and right of the unit is more than 12cm.
- Use a stud finder to locate studs to prevent unnecessary damage to the wall.
- A minimum pipe run of 3 metres is required to minimise vibration & excessive noise.
- The indoor unit should be installed on the wall at a height of 2.3 metres or more from the floor.
- The indoor unit should be installed allowing a minimum clearance of 15cm from the ceiling.
- Any variations in pipe length will/may require adjustment to refrigerant charge.

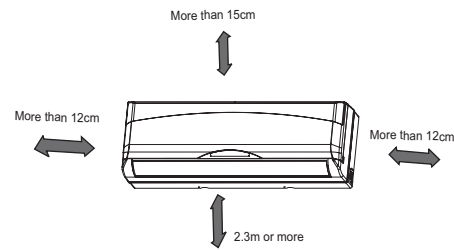
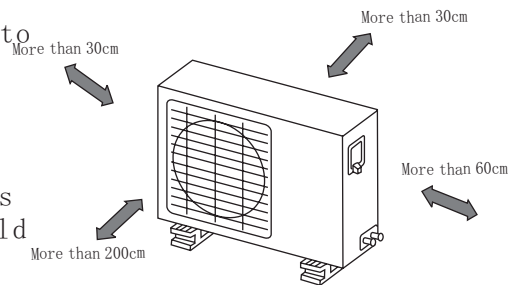

Fig.1

Outdoor unit

- If an awning is built over the outdoor unit to prevent direct sunlight or rain exposure, make sure that heat radiation from the condenser is not restricted.
- Ensure that the clearance around the back of the unit is more than 30cm and left side is more than 30cm . The front of the unit should have more than 200cm of clearance and the connection side (right side) should have more than 60cm of clearance.
- Do not place animals and plants in the path of the air inlet or outlet.
- Take the air conditioner weight into account and select a place where noise and vibration will not be an issue.
- Select a place so that the warm air and noise from the air conditioner do not disturb neighbors.



Rooftop installation:

- If the outdoor unit is installed on a roof structure, be sure to level the unit.
- Ensure the roof structure and anchoring method are adequate for the unit location.
- Consult local codes regarding rooftop mounting.
- If the outdoor unit is installed on roof structures or external walls, this may result in excessive noise and vibration, and may also be classed as a non serviceable installation.

Items packed with the unit

Number	Name of Accessories		Q' ty	
1	Installation Plate		1	
2	Clip Anchor		8	
3	Self-tapping Screw A ST3.9X25		8	
4	Seal		1	
5	Drain Joint		1	
6	Connecting pipe Assembly	Liquid side	Φ 6.35	Parts you must purchase (A Minimum pipe wall-thickness of 0.7mm is required)
		Gas side	Φ 9.53 (<12000Btu/h model)	
			Φ 12.7 (\geq 12000Btu/h model)	
7	Remote controller		1	
8	Self-tapping Screw B ST2.9X10		2	
9	Remote controller holder		1	

Note: Except the above parts provided, the other parts needed during installation you must purchase.

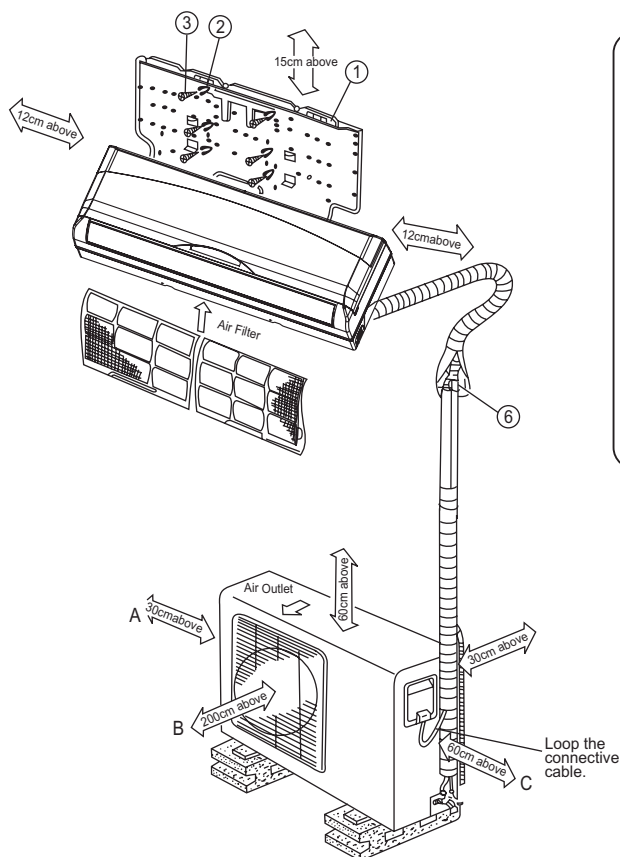
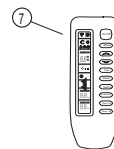

Fig.3

CAUTION

- Ensure that the space around the left and right of the indoor unit is more than 12cm. The indoor unit should be installed allowing a minimum clearance of 15cm from the ceiling.
- Use a stud finder to locate studs to prevent unnecessary damage to the wall.
- A minimum pipe run of 3 metres is required to minimise vibration & excessive noise.
- The indoor unit should be installed on the wall at a height of 2.3 metres or more from the floor.
- At least two of the Directions A, B and C should be free from obstructions.

Remote Controller



Mounting screw B
ST2.9x10-C-H



Remote controller holder

- This illustration is for explanation purposes only.
- Copper lines must be insulated independently

INDOOR UNIT INSTALLATION

1. Fit the Installation Plate

1. Fit the installation plate horizontally on structural parts of the wall with spaces around the installation plate.
2. If the wall is made of brick, concrete or the like, drill eight (8) 5mm diameter holes in the wall. Insert Clip anchor for appropriate mounting screws.
3. Fit the installation plate on the wall with eight (8) type "A" screws.

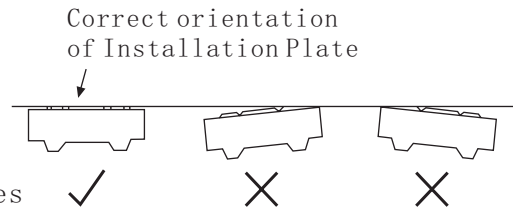

Fig.4

Note:

Fit the Installation Plate and drill holes in the wall according to the wall structure and corresponding mounting points on the installation plate.

(Dimensions are in "mm" unless otherwise stated)

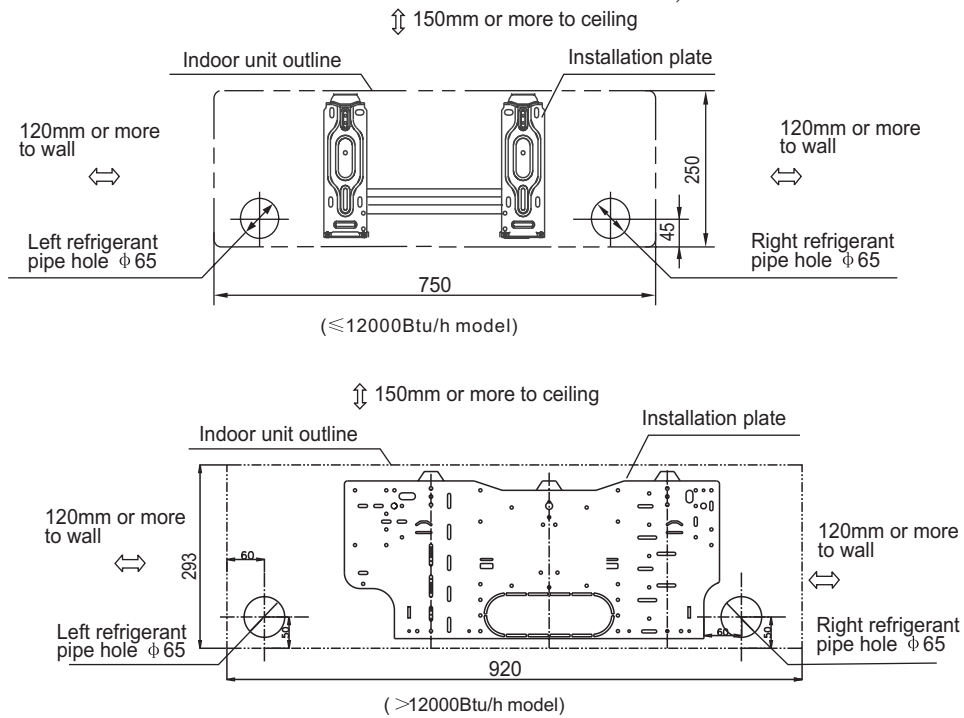

Fig.5

2. Drill a hole in the wall

1. Determine hole positions according to the diagram detailed in Fig. 5. Drill one (1) hole ($\phi 65\text{mm}$) slanting slightly to outdoor side.
2. Always use wall hole conduit when drilling metal grid, metal plate or the like.

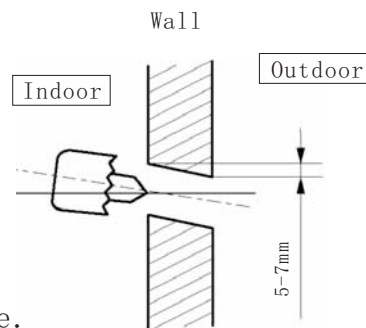

Fig.6

3. Connective Pipe and Drainage Installation

Drainage

1. Run the drain hose sloping downward. Do not install the drain hose as illustrated below.

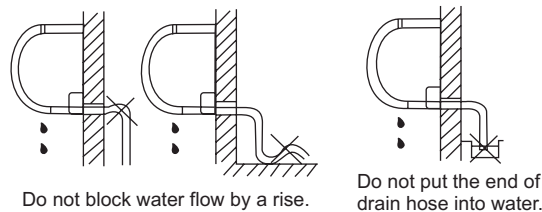

Fig.6

2. When connecting extension drain hose, insulate the connecting part of extension drain hose with a shield pipe, do not let the drain hose slack.

Connective pipe

1. For the left-hand and right-hand piping, remove the pipe cover from the side panel.
 - Explain to clients that the pipe cover must be kept as it may be used when relocate the air conditioner to any other place.
2. For the rear-right-hand and rear-left-hand piping, install the piping as shown. Bend the connective pipe to be laid at 43mm height or less from the wall.
3. Fix the end of the connective pipe. (Refer to Tightening Connection in REFRIGERANT PIPING CONNECTION)

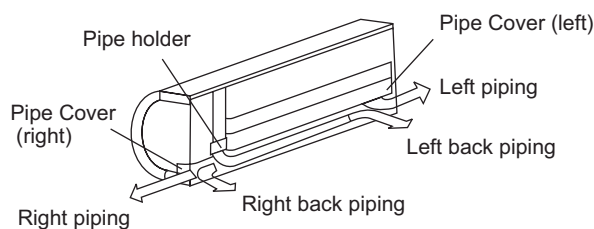

Fig.7

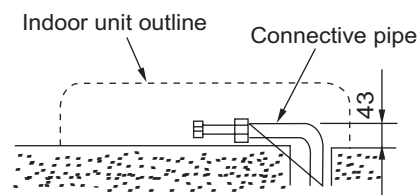

Fig.8

4. Indoor unit installation

1. Pass the piping through the hole in the wall.
2. Put the upper claw at the back of the indoor unit on the upper hook of the installation plate, move the indoor unit from side to side to see that it is securely hooked.
3. Piping can easily be made by lifting the indoor unit with a cushioning material between the indoor unit and the wall. Get it out after finish piping.
4. Push the lower part of the indoor unit up on the wall, Then move the indoor unit from side to side, up and down to check if it is hooked securely.

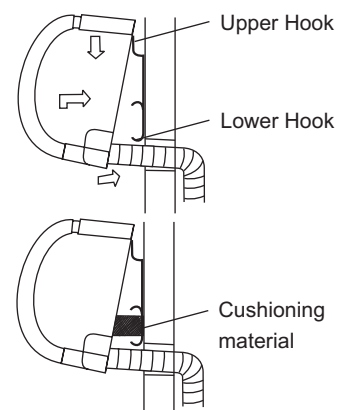

Fig.9

5. Piping and wrapping

Bundle the tubing, connecting cable, and drain hose with tape securely, evenly as shown in Fig.10.

- Because the condensed water from rear of the indoor unit is gathered in ponding box and is piped out of room. Do not put anything else in the box.

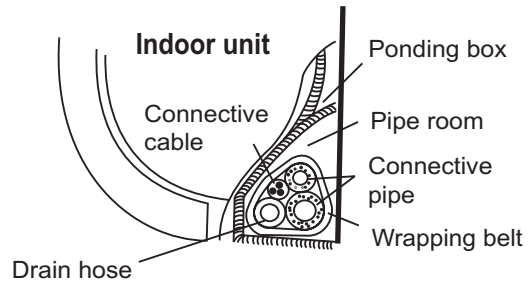

Fig.10

CAUTION

- Connect the indoor unit first, then the outdoor unit.
- Do not allow the piping to let out from the back of the indoor unit.
- Be careful not to let the drain hose slack.
- Heat insulated both of the auxiliary piping.
- Be sure that the drain hose is located at the lowest side of the bundle. Locating at the upper side can cause drain pan to overflow inside the unit.
- Never intercross nor intertwist the power wire with any other wiring.
- Run the drain hose sloped downward to drain out the condensed water smoothly.

OUTDOOR UNIT INSTALLATION

Outdoor installation precaution

- Install the outdoor unit on a rigid base to prevent increasing noise level and vibration.
- Determine the air outlet direction where the discharged air is not blocked.
- In the case that the installation place is exposed to strong wind such as a seaside, make sure the fan operating properly by putting the unit lengthwise along the wall or using a dust or shield plates.
- Specially in windy area, install the unit to prevent the admission of wind.
- If need suspending installation, the installation bracket should accord with technique requirement in the installation bracket diagram. The installation wall should be solid brick, concrete or the same intensity construction, or actions to reinforce, damping supporting should be taken. The connection between bracket and wall, bracket and the air conditioner should be firm, stable and reliable.
- Be sure there is no obstacle which block radiating air.

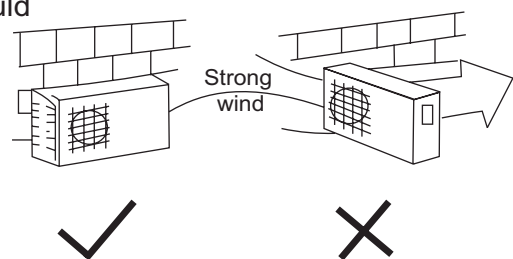

Fig.11

Settlement of outdoor unit

- Anchor the outdoor unit with a bolt and nut $\phi 10$ or $\phi 8$ tightly and horizontally on a concrete or rigid mount.

Model	A(mm)	B(mm)
<18000Btu/h	530	290
≥ 18000 Btu/h	560	335

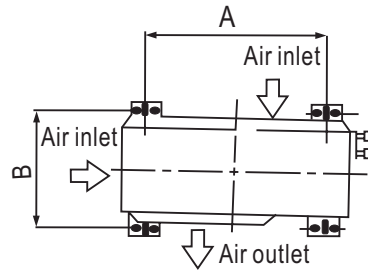

Fig.12

Drain joint installation

Fit the seal into the drain elbow, then insert the drain joint into the base pan hole of outdoor unit, rotate 90° to securely assemble them. Connecting the drain joint with an extension drain hose (Locally purchased), in case of the water draining off the outdoor unit during the heating mode.

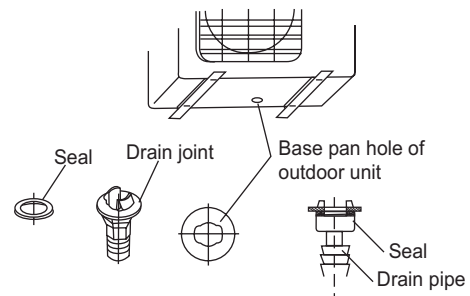

Fig.13

REFRIGERANT PIPING CONNECTION

1. Flaring work

Main cause for refrigerant leakage is due to defect in the flaring work. Carry out correct flaring work using the following procedure:

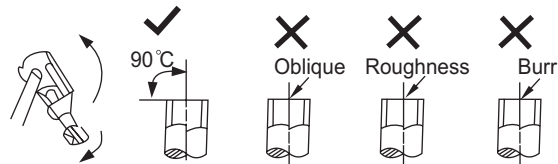

Fig.14

A: Cut the pipes and the cable.

- Use the piping kit accessory or pipes purchased locally.
- Measure the distance between the indoor and the outdoor unit.
- Cut the pipes a little longer than the measured distance.
- Cut the cable 1.5m longer than the pipe length.

B: Burr removal

- Completely remove all burrs from the cut cross section of pipe/tube.
- Put the end of the copper tube/pipe in a downward direction as you remove burrs in order to avoid dropping burrs into the tubing.

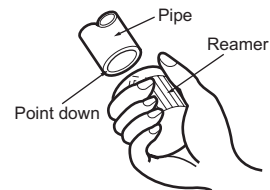

Fig.15

C: Putting nut on

Remove flare nuts attached to indoor and outdoor unit, then put them on pipe/tube having completed burr removal. (not possible to put them on after flaring work)

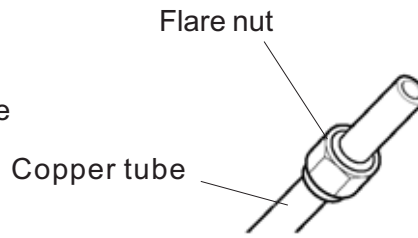

Fig.16

D: Flaring work

Firmly hold copper pipe in a die in the dimension shown in the table below.

Outer diam. (mm)	A(mm)	
	Max.	Min.
φ 6.35	1.3	0.7
φ 9.53	1.6	1.0
φ 12.7	1.8	1.0

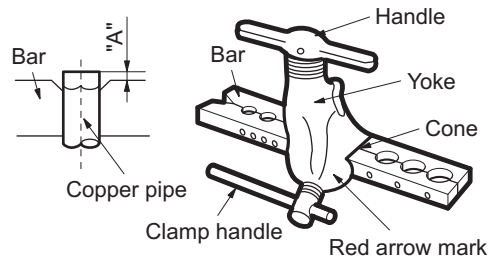

Fig.17

Tightening Connection

- Align the center of the pipes..
- Sufficiently tighten the flare nut with fingers, and then tighten it with a spanner and torque wrench as shown.

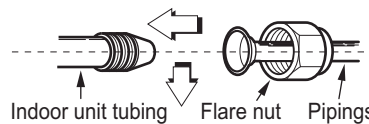

Fig.18

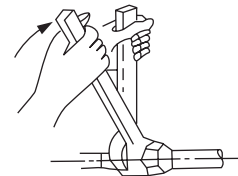

Fig.19

CAUTION

- Excessive torque can break nut depending on installation conditions.

Outer diam.	Tightening torque(N.cm)	Additional tightening torque(N.cm)
φ 6.35	1570 (160kgf.cm)	1960 (200kgf.cm)
φ 9.53	2940 (300kgf.cm)	3430 (350kgf.cm)
φ 12.7	4900 (500kgf.cm)	5390 (550kgf.cm)

ELECTRICAL WORK

Electric safety regulations for the initial Installation

1. If there is serious safety problem about the power supply, the technicians should refuse to install the air conditioner and explain to the client until the problem is solved.
2. Power voltage should be in the range of 90%~110%of rated voltage.
3. The creepage protector and main power switch with a 1.5 times capacity of Max. Current of the unit should be installed in power circuit.
4. Ensure the air conditioner is grounded well.
5. According to the attached Electrical Connection Diagram located on the panel of the outdoor unit to connect the wire.
6. All wiring must comply with local and national electrical codes and be installed by qualified and skilled electricians.
7. An individual branch circuit and single receptacle used only for this air conditioner must be available. See the following table for suggested wire sizes and fuse specifications:

Model	Power supply	Input Rated Amp (Switch/Fuse)	Power Cord Size
< 12000Btu/h	220-240V~ 50Hz or 220-230V~60Hz	25A	1.5mm ²
≥ 12000Btu/h	220-230V~60Hz	25A	2.5mm ²

NOTE: The supply voltage should be consistent with the rated voltage of the air conditioner.

Connect the cable to the indoor unit

1. Indoor/Outdoor connection cable should be H07RN-F type.
2. Remove the panel and Screw, then remove the window cover.
3. Connect cables according to their marks to terminals.
4. Wrap those cables not connected with terminals with insulation tapes, so that they will not touch any electrical components.

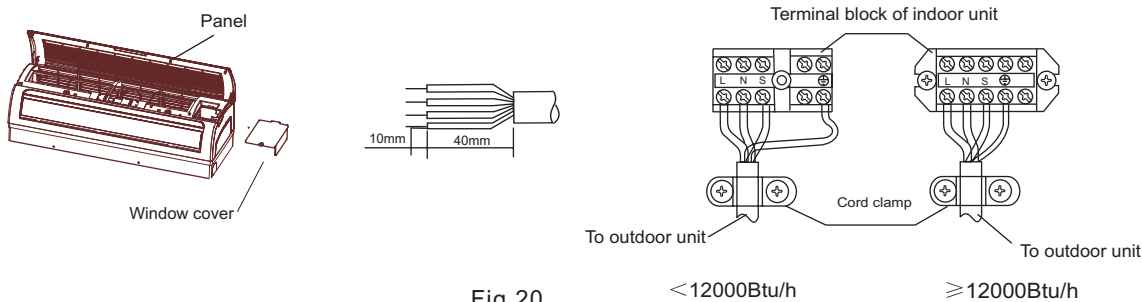

Fig.20

Connect the cable to the outdoor unit

1. Remove the electric parts cover from the outdoor unit.
2. Connect the connective cables to the terminals as identified with their respective matched numbers on the terminal block of indoor and outdoor units.
3. To prevent the ingress of water, from a loop of the connective cable as illustrated in the installation diagram of indoor and outdoor units.
4. Insulate unused cords (conductors) with PVC-tape. Process them so they do not touch any electrical or metal parts.

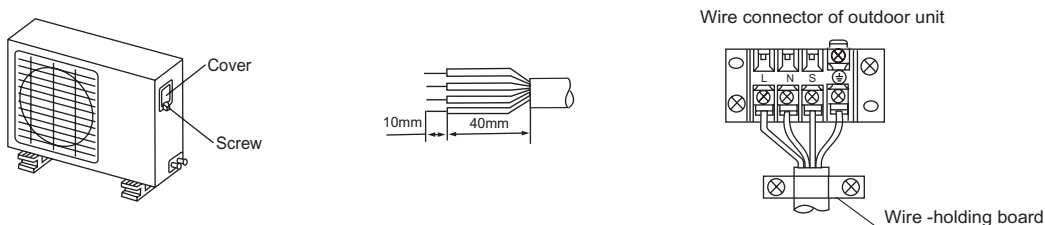

Fig.21

CAUTION

After the confirmation of the above conditions, prepare the wiring as follows:

- 1) **Never fail to have an individual power circuit specifically for the air conditioner. As for the method of wiring, be guided by the circuit diagram posted on the inside of control cover.**
- 2) **The screw which fasten the wiring in the casing of electrical fittings are liable to come loose from vibrations to which the unit is subjected during the course of transportation. Check them and make sure that they are all tightly fastened. (If they are loose, it could cause burn-out of the wires.)**
- 3) **Specification of power source.**
- 4) **Confirm that electrical capacity is sufficient.**
- 5) **See to that the starting voltage is maintained at more than 90 percent of the rated voltage marked on the name plate.**
- 6) **Confirm that the cable thickness is as specified in the power source specification.**
- 7) **Always install an earth leakage circuit breaker in a wet or moist area.**
- 8) **The following would be caused by voltage drop.**
Vibration of a magnetic switch, which will damage the contact point, fuse breaking, disturbance of the normal function of the overload.
- 9) **The means for disconnection from a power supply shall be incorporated in the fixed wiring and have an air gap contact separation of at least 3mm in each active(phase) conductors.**

AIR PURGING

Air and moisture in the refrigerant system have undesirable effects as indicated below:

- Pressure in the system rises.
- Operating current rises.
- Cooling or heating efficiency drops.
- Moisture in the refrigerant circuit may freeze and block capillary tubing.
- Water may lead to corrosion of parts in the refrigeration system.

Therefore, the indoor unit and tubing between the indoor and outdoor unit must be leak tested and evacuated to remove any noncondensables and moisture from the system.

Air purging with vacuum pump

- Preparation
Check that each tube(both liquid and gas side tubes) between the indoor and outdoor units have been properly connected and all wiring for the test run has been completed. Remove the service valve caps from both the gas and the liquid side on the outdoor unit. Note that both the liquid and the gas side service valves on the outdoor unit are kept closed at this stage.
- Pipe length and refrigerant amount:

Connective pipe length	Air purging method	Additional amount of refrigerant to be charged
Less than 5m	Use vacuum pump.	—————
5~12m	Use vacuum pump.	Liquid side: $\phi 6.35$ (Pipe length-5)x30g

- When relocate the unit to another place, perform evacuation using vacuum pump.
- Make sure the refrigerant added into the air conditioner is liquid form in any case. (Not applicable to the units with R22 refrigerant)

Caution in handling the packed valve

- Open the valve stem until it hits against the stopper. Do not try to open it further.
- Securely tighten the valve stem cap with a spanner or the like.
- Valve stem cap tightening torque (See Tightening torque table in previous page).

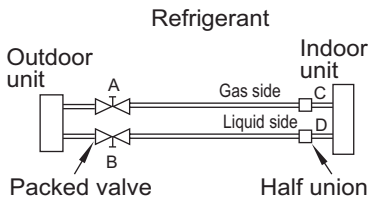

Fig.22

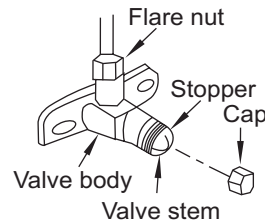

Fig.23

When Using the Vacuum Pump

(For method of using a manifold valve, refer to its operation manual.)

1. Completely tighten the flare nuts, A, B, C, D, connect the manifold valve charge hose to a charge port of the low-pressure valve on the gas pipe side.
2. Connect the charge hose connection to the vacuum pump.
3. Fully open the handle Lo of the manifold valve.
4. Operate the vacuum pump to evacuate. After starting evacuation, slightly loose the flare nut of the Lo valve on the gas pipe side and check that the air is entering (Operation noise of the vacuum pump changes and a compound meter indicates 0 instead of minus)
5. After the evacuation is complete, fully close the handle Lo of the manifold valve and stop the operation of the vacuum pump. Make evacuation for 15 minutes or more and check that the compound meter indicates -76cmHg (-1x10⁵Pa).
6. Turn the stem of the packed valve B about 45° counterclockwise for 6~7 seconds after the gas coming out, then tighten the flare nut again. Make sure the pressure display in the pressure indicator is a little higher than the atmosphere pressure.
7. Remove the charge hose from the Low pressure charge hose.
8. Fully open the packed valve stems B and A.
9. Securely tighten the cap of the packed valve.

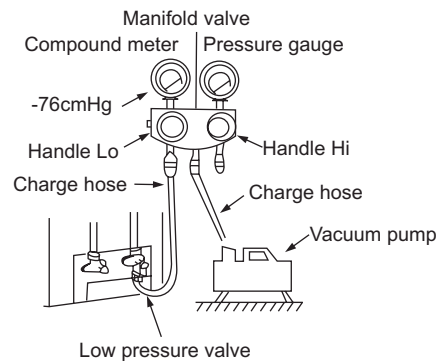

Fig.24

ELECTRICAL SAFETY AND GAS LEAK CHECK

● Electrical safety check

Perform the electric safe check after completing installation:

1. Insulated resistance

The insulated resistance must be more than $2M\ \Omega$.

2. Grounding work

After finishing grounding work, measure the grounding resistance by visual detection and grounding resistance tester. Make sure the grounding resistance is less than $4\ \Omega$.

3. Electrical leakage check (performing during test running)

During test operation after finishing installation, the serviceman can use the electroprobe and multimeter to perform the electrical leakage check. Turn off the unit immediately if leakage happens. Check and find out the solution ways till the unit operate properly.

● Gas leak check

1. Soap water method:

Apply a soap water or a liquid neutral detergent on the indoor unit connection or outdoor unit connections by a soft brush to check for leakage of the connecting points of the piping. If bubbles come out, the pipes have leakage.

2. Leak detector

Use the leak detector to check for leakage.

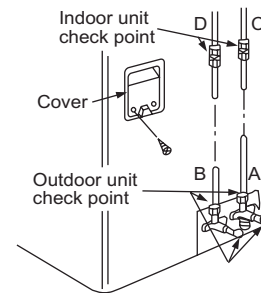

Fig.25

CAUTION

A: Lo packed valve B: Hi packed valve
C and D are ends of indoor unit connection.

TEST RUNNING

Perform test running after completing gas leak and electrical safety check.

The test running time should last more than 30 minutes.

1. Open the panel and lift the panel up to an angle which remains fixed. Do not lift the panel any further when it stops with a "click" sound.
2. Press the manual control button twice until the operating indicator lights up, the unit will operate on Forced Cool mode.
3. Check if all the functions works well during test running. Especially check whether the drainage of indoor unit is smooth or not.
4. Press the manual switch button again after finishing the test running. The operating indicator turns dark and the unit stops operating.

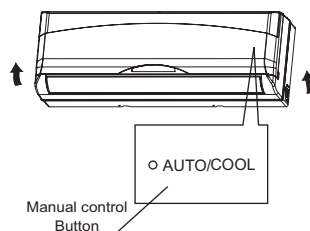

CS336-I

2200019109